

NPN Digital Transistors (Built-in Resistors)

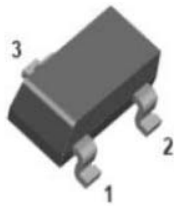
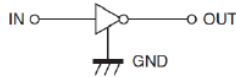
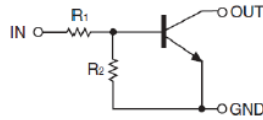

1. IN
2. GND
3. OUT

SOT-323

Features

- Moisture sensitivity level 1
- Halogen free and RoHS compliant
- Surface mount package ideally suited for automatic insertion

Application

- Signal amplification
- Switching circuit

Mechanical data

- **Package:** SOT-323
- **Terminals:** Tin plated leads, solderable per J-STD-002 and JESD22-B102

■ Maximum Ratings ($T_a=25^\circ\text{C}$ Unless otherwise specified)

Item	Symbol	Unit	Conditions	Value
Device marking code				24
Collector-base voltage	V_{CC}	V		50
Collector-emitter voltage	V_{IN}	V		-10 to +40
Collector current	I_o	mA		100
Power dissipation	P_D	mW		200
Junction temperature	T_J	$^\circ\text{C}$		-55 to +150
Storage temperature	T_{STG}	$^\circ\text{C}$		-55 to +150



DTC114EUA

RoHS
COMPLIANT

■ Electrical Characteristics (T_a=25°C Unless otherwise specified)

Item	Symbol	Unit	Conditions	Min	Typ	Max
Input voltage	V _{I(off)}	V	V _{CC} =5V, I _C =100uA	0.5		
	V _{I(on)}	V	V _O =0.3V, I _C =10mA			3
Output voltage	V _{O(on)}	V	I _O / I _I = 10mA / 0.5 mA			0.3
Input current	I _I	mA	V _I =5V			0.88
Output current	I _{O(off)}	uA	V _{CC} =50V, V _I =0			0.1
DC current gain	G _I		V _O =5V, I _O =5mA	33		
Input resistance	R ₁	kΩ		7	10	13
Resistance ratio	R ₂ /R ₁			0.8	1	1.2
Transition frequency	f _T	MHz	V _O =10V, I _O =5mA, f=100MHz		250	

■ Thermal Characteristics

Parameter	Symbol	Unit	Value
Thermal resistance, junction-to-ambient	R _{θJ-A} ⁽¹⁾	°C/W	625
Thermal resistance, junction-to-case	R _{θJ-C} ⁽¹⁾	°C/W	500

Note:

(1) Device mounted on PCB, single-sided copper, with standard footprint



■ Characteristics

Fig 1: Input Voltage (On) Characteristics

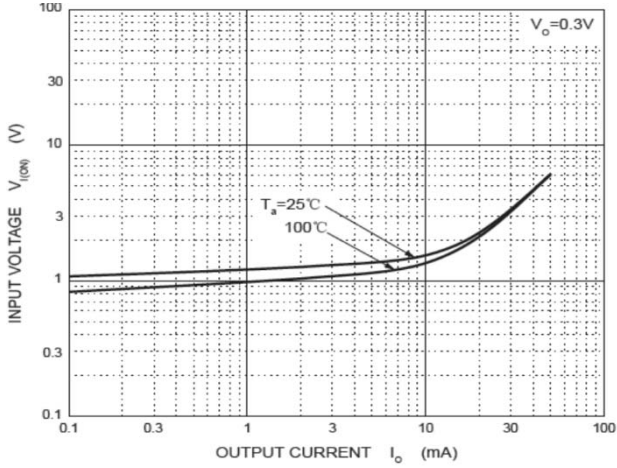

Fig 2: Input Voltage (Off) Characteristic

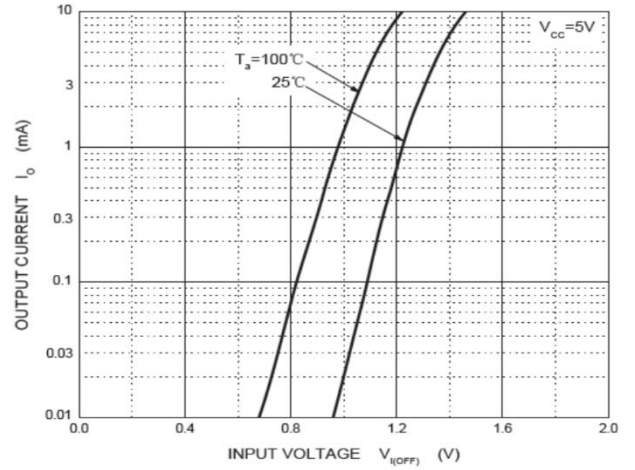

Fig 3: DC Current Gain Characteristics

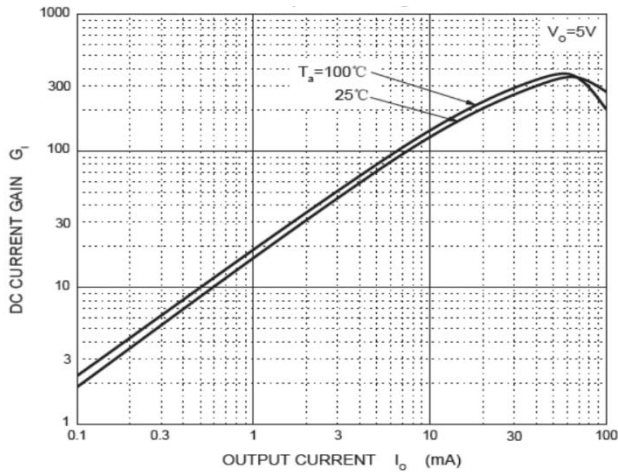

Fig 4: Output Voltage Characteristics

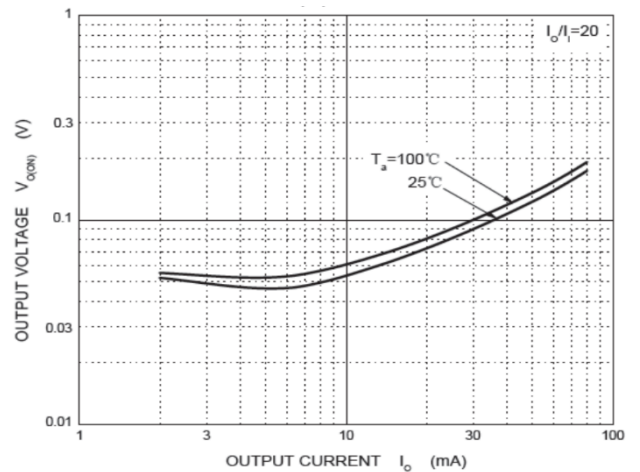
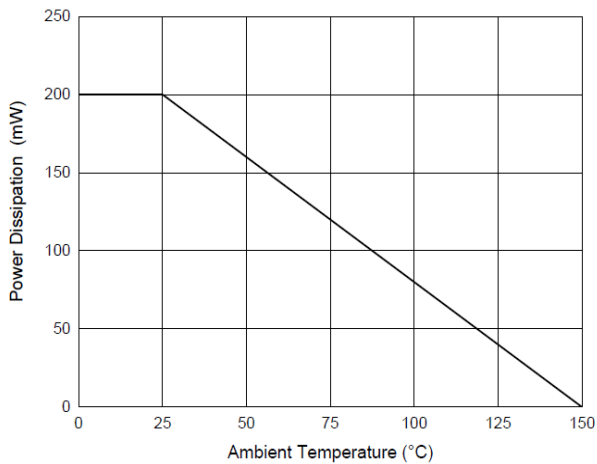

Fig 5: P_D-Ta Curve





DTC114EUA

RoHS
COMPLIANT

Ordering Information

Preferred P/N	Packing code	Unit weight(g)	Minimum package(pcs)	Inner box quantity(pcs)	Outer carton quantity(pcs)	Delivery mode
DTC114EUA	F2	Approximate 0.005	3000	30000	120000	7" reel

Outline Dimensions

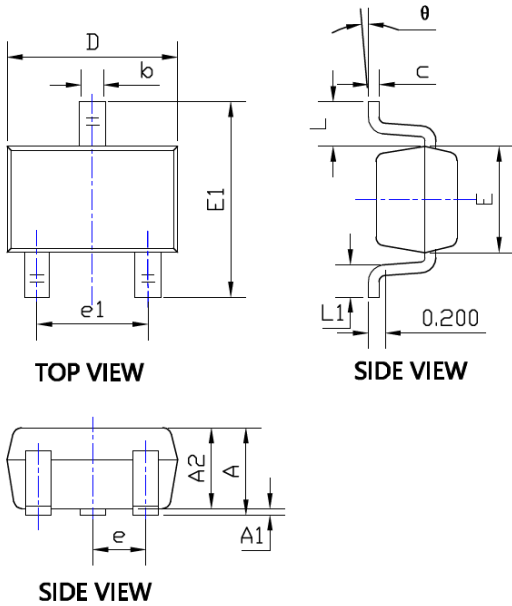

SYMBOL	DIMENSIONS			
	INCHES		Millimeter	
	MIN.	MAX.	MIN.	MAX.
A	0.035	0.043	0.900	1.100
A1	0.000	0.004	0.000	0.100
A2	0.035	0.039	0.900	1.000
b	0.006	0.016	0.150	0.400
c	0.004	0.010	0.100	0.250
D	0.071	0.087	1.800	2.200
E	0.045	0.053	1.150	1.350
E1	0.085	0.096	2.150	2.450
e	0.026 TYP		0.650 TYP	
e1	0.047	0.055	1.200	1.400
L	0.021 REF		0.525 REF	
L1	0.010	0.018	0.260	0.460
θ	0°	8°	0°	8°

Suggested Pad Layout

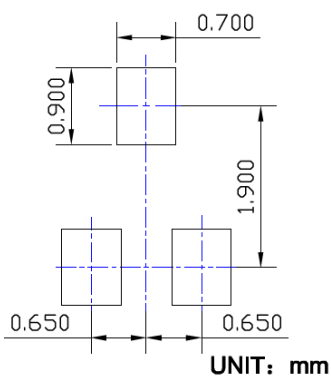



Disclaimer

The information presented in this document is for reference only. Yangzhou Yangjie Electronic Technology Co., Ltd. reserves the right to make changes without notice for the specification of the products displayed herein to improve reliability, function, or design or otherwise.

The product listed herein is designed to be used with ordinary electronic equipment or devices, and not designed to be used with equipment or devices which require high level of reliability and the malfunction of which would directly endanger human life (such as medical instruments, transportation equipment, aerospace machinery, nuclear-reactor controllers, fuel controllers and other safety devices), Yangjie or anyone on its behalf, assumes no responsibility or liability for any damages resulting from such improper use of sale.

This publication supersedes & replaces all information previously supplied. For additional information, please visit our website [http:// www.21yangjie.com](http://www.21yangjie.com) , or consult your nearest Yangjie's sales office for further assistance.