

## Small-Signal Switching Diodes

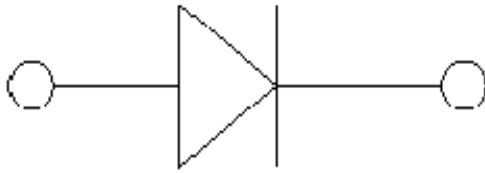

### Features

- $V_R$  80V
- $I_{FAV}$  150mA

### Typical Applications

- Extreme fast switches

### Mechanical Data

- **Package:** SOD323
- **Terminals:** Tin plated leads, solderable per J-STD-002 and JESD22-B102
- **Polarity:** Cathode line denotes the cathode end
- **Marking:** A

### ■ Maximum Ratings ( $T_a=25^\circ\text{C}$ Unless otherwise specified)

PARAMETER	SYMBOL	UNIT	Conditions	VALUE
Repetitive peak reverse voltage	$V_{RRM}$	V		90
Maximum DC Blocking	$V_{DC}$	V		80
Peak forward surge current	$I_{FSM}$	A	$t_p=1\mu\text{s}$	2
Average forward current	$I_{FAV}$	mA		150
Power dissipation	$P_{tot}$	mW		200
Maximum junction temperature	$T_j$	$^\circ\text{C}$		-65 to +150
Storage temperature range	$T_{stg}$	$^\circ\text{C}$		-65 to +150

### ■ Electrical Characteristics ( $T_a=25^\circ\text{C}$ Unless otherwise specified)

PARAMETER	SYMBOL	UNIT	Conditions	VALUE
Maximum Forward voltage	$V_F$	mV	$I_F=100\text{mA}$	1200
Maximum Reverse current	$I_R$	nA	$V_R=80\text{V}$	100
Minimum Breakdown voltage	$V_R$	V	$I_R=1\mu\text{A}$	80
Maximum Diode capacitance	$C_D$	pF	$V_R=6.0\text{V}, f=1\text{MHz}$	3.0
Maximum Reverse recovery time	$t_{rr}$	ns	$I_F=10\text{mA}, V_R=6\text{V}$	4



# 1SS355

## Ordering Information (Example)

PREFERED P/N	PACKING CODE	UNIT WEIGHT(g)	MINIMUM PACKAGE(pcs)	INNER BOX QUANTITY(pcs)	OUTER CARTON QUANTITY(pcs)	DELIVERY MODE
1SS355	F2	Approximate 0.0048	3000	30000	120000	7" reel

## Characteristics (Typical)

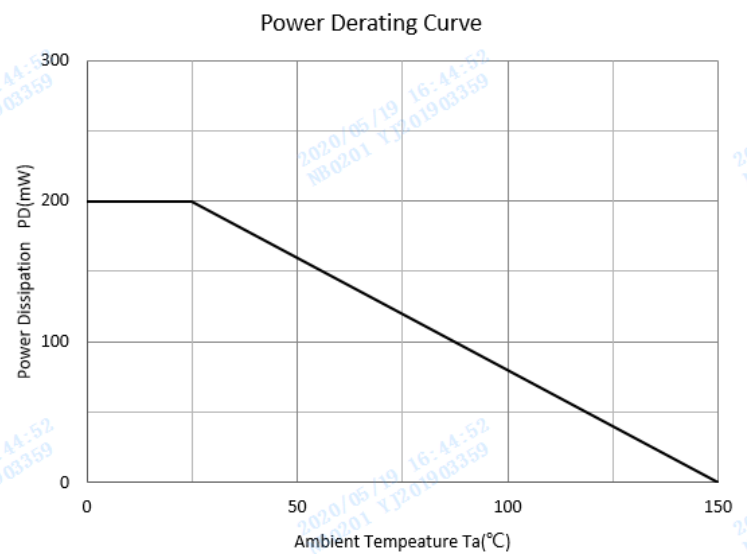
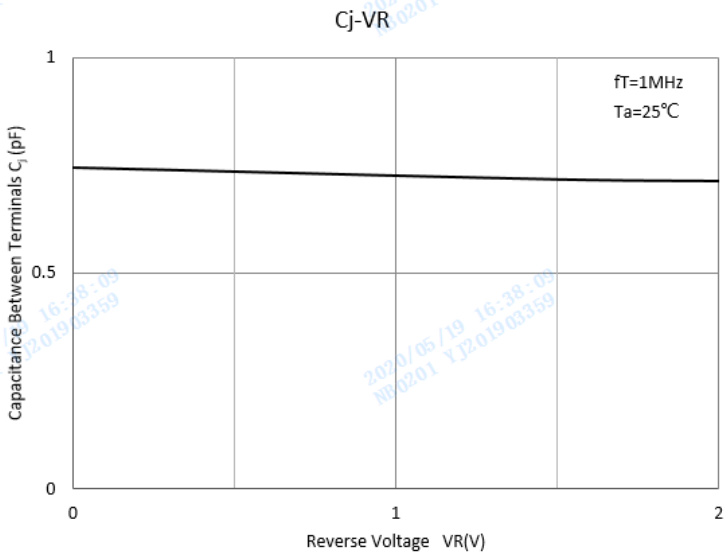
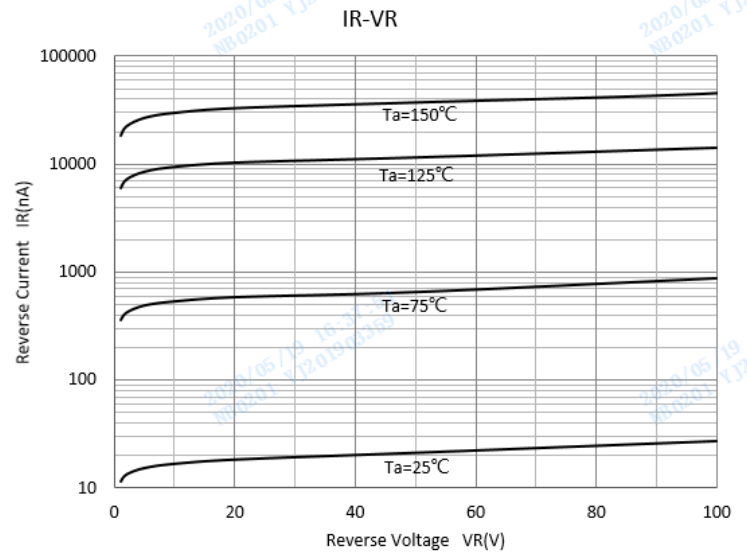
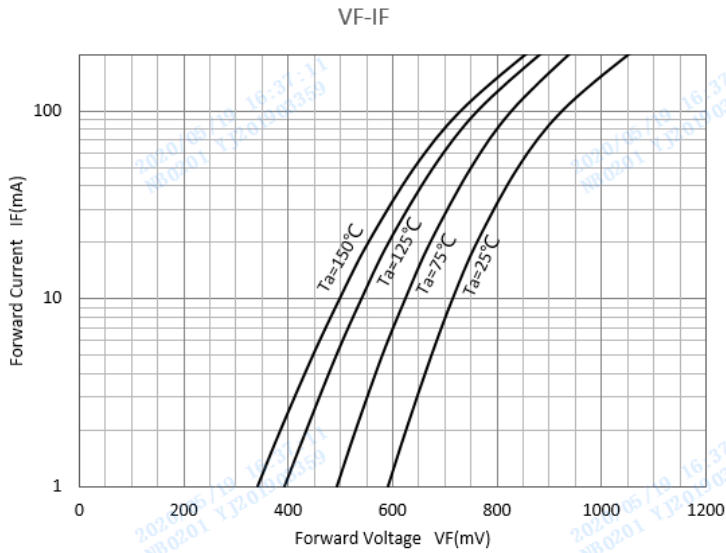



# 1SS355

## ■Outline Dimensions

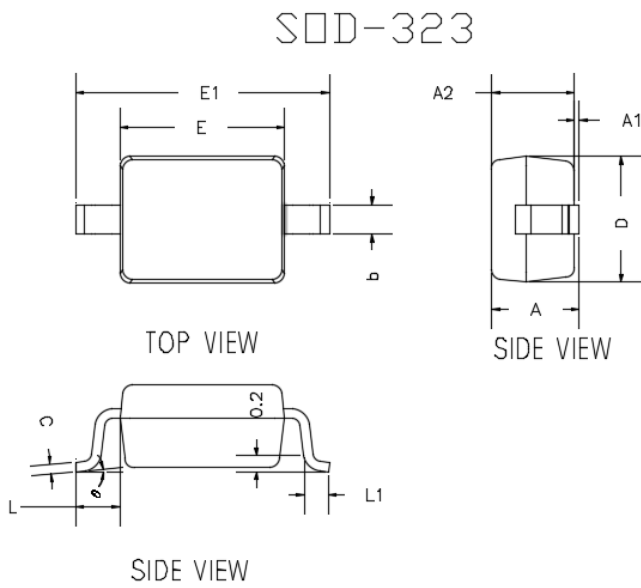

DIMENSIONS				
DIM	INCHES		MM	
	MIN	MAX	MIN	MAX
A	---	0.0393	---	1.0000
A1	0.0000	0.0039	0.0000	0.1000
A2	0.0314	0.0354	0.8000	0.9000
b	0.0098	0.0157	0.2500	0.4000
c	0.0031	0.0059	0.0800	0.1500
D	0.0472	0.0551	1.2000	1.4000
E	0.0629	0.0709	1.6000	1.8000
E1	0.0984	0.1063	2.5000	2.7000
L	0.0187TYP		0.475TYP	
L1	0.0098	0.0157	0.250	0.400
e	0°	8°	0°	8°

## ■Soldering Footprint

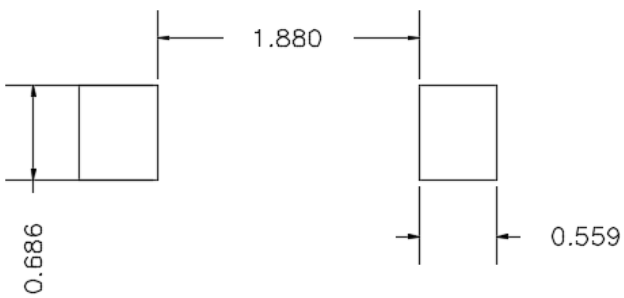

UNIT : mm

SUGGESTED SOLDER PAD LAYOUT



## Disclaimer

The information presented in this document is for reference only. Yangzhou Yangjie Electronic Technology Co., Ltd. reserves the right to make changes without notice for the specification of the products displayed herein to improve reliability, function or design or otherwise.

The product listed herein is designed to be used with ordinary electronic equipment or devices, and not designed to be used with equipment or devices which require high level of reliability and the malfunction of which would directly endanger human life (such as medical instruments, transportation equipment, aerospace machinery, nuclear-reactor controllers, fuel controllers and other safety devices), Yangjie or anyone on its behalf, assumes no responsibility or liability for any damages resulting from such improper use of sale.

This publication supersedes & replaces all information previously supplied. For additional information, please visit our website [http:// www.21yangjie.com](http://www.21yangjie.com) , or consult your nearest Yangjie's sales office for further assistance.