



FRED Modules

V_{RRM} 600V

I_{FAV} 100 A

Applications

- Inversion Welder
- Uninterruptible Power Supply (UPS)
- Plating Power Supply
- Ultrasonic Cleaner and Welder
- Power Factor Correction (PFC) Circuit
- Converter & Chopper

Features

- Soft Reverse Recovery Characteristics
- Ultrafast Reverse Recovery Time
- Low Reverse Recovery Loss
- Low Forward Voltage
- High Surge Current Capability
- Low Inductance Package

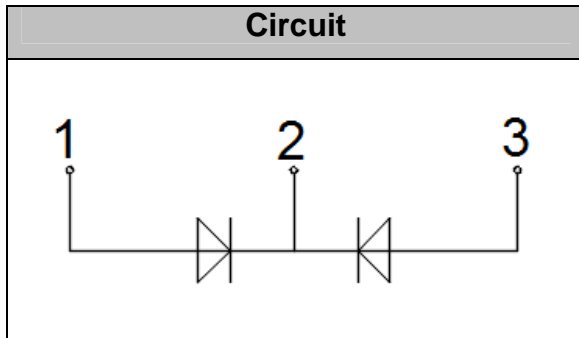

Module Type

TYPE	V _{RRM}	V _{RSM}
MF100A06F2N	600V	660V

Maximum Ratings

Symbol	Conditions	Values	Units
V _R		600	V
V _{RRM}		600	V
I _{F(AV)}	T _C =95°C, Per Diode	100	A
I _{F(RMS)}	T _C =95°C, Per Diode	150	A
I _{FSM}	1/2 Cycle, 50Hz, Sine	1300	A
	1/2 Cycle, 60Hz, Sine	1425	A
I ² t	T _J =45°C, t=10ms, 50Hz, Sine	8450	A ² s
P _D		280	W
Visol	AC, Ton=1min	3000	V
T _J		-40 to +150	°C
T _{STG}		-40 to +125	°C
Torque	Recommended (M6)	4.5 ± 15%	N·m
Torque	Recommended (M6)	4.5 ± 15%	N·m
Weight		160	g

Thermal Characteristics

Symbol	Conditions	Values	Units
R _{th(j-c)}	Per diode	0.22	°C/W



Electrical Characteristics

Symbol	Conditions	Values			Units
		Min.	Typ.	Max.	
I_{RM}	$V_R=600V$	--	--	50	μA
	$V_R=600V, T_J=125^\circ C$	--	--	1	mA
V_F	$I_F=100A$	--	1.25	1.4	V
	$I_F=100A, T_J=125^\circ C$	--	1.1	1.3	V
trr	$I_F=1A, V_R=30V, di_F/dt=-200A/\mu s$	--	45	50	ns
trr	$V_R=300V, I_F=100A, di_F/dt=-200A/\mu s, T_J=25^\circ C$	--	105	--	ns
I_{RRM}		--	10	--	A
trr	$V_R=300V, I_F=100A, di_F/dt=-200A/\mu s, T_J=125^\circ C$	--	200	--	ns
I_{RRM}		--	18	--	A

Performance Curves

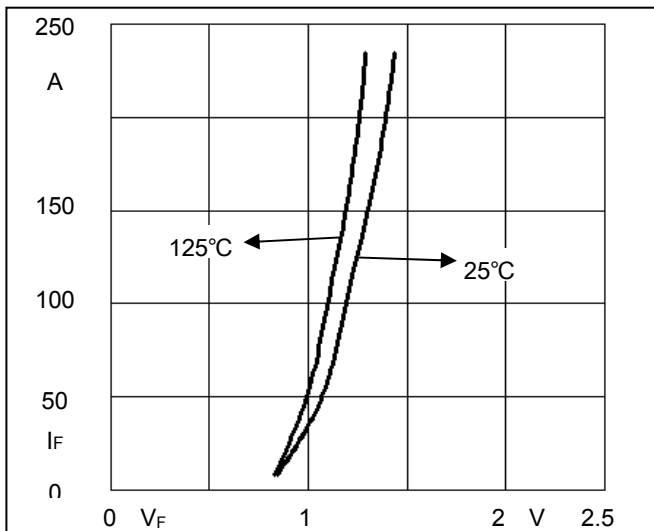

Fig1. Forward Voltage Drop vs Forward Current

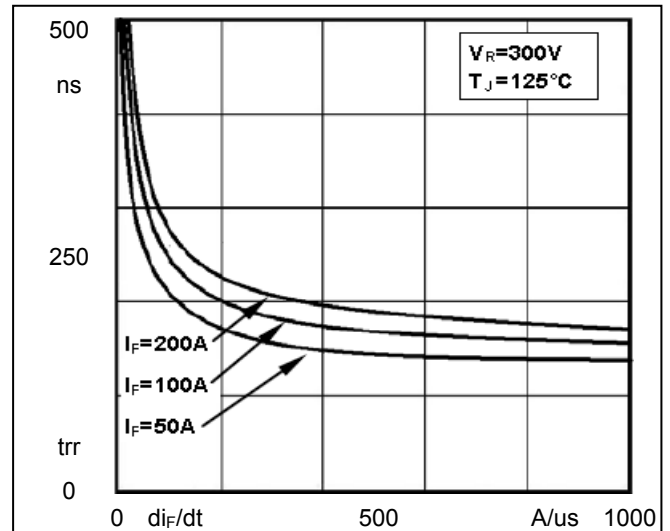

Fig2. Reverse Recovery Time vs di_F/dt

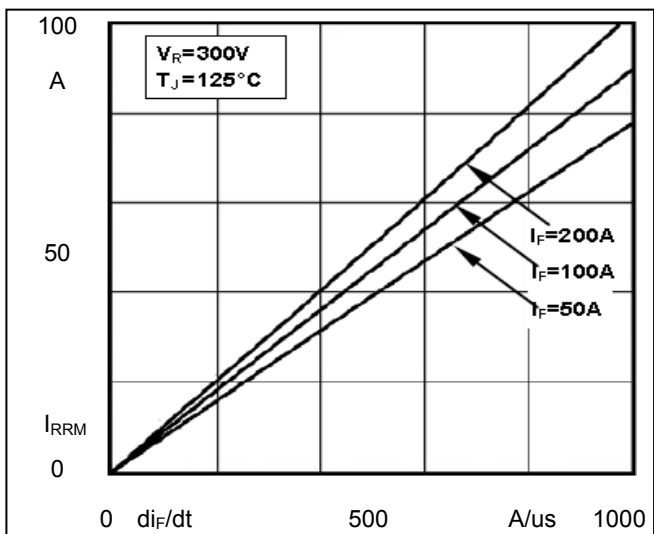

Fig3. Reverse Recovery Current vs di_F/dt

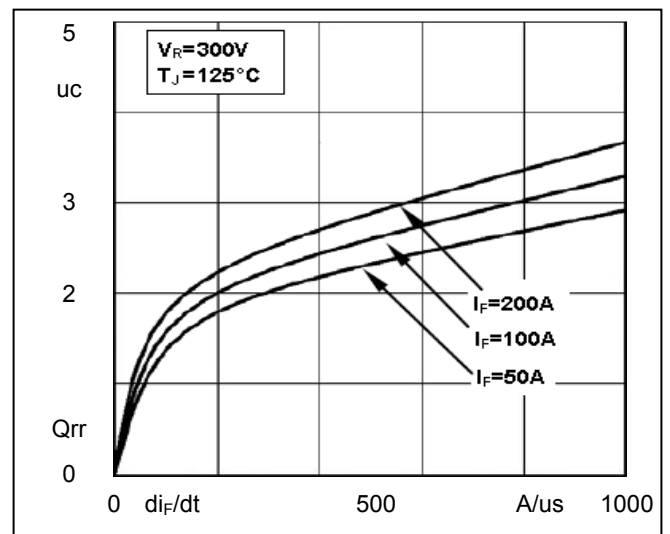
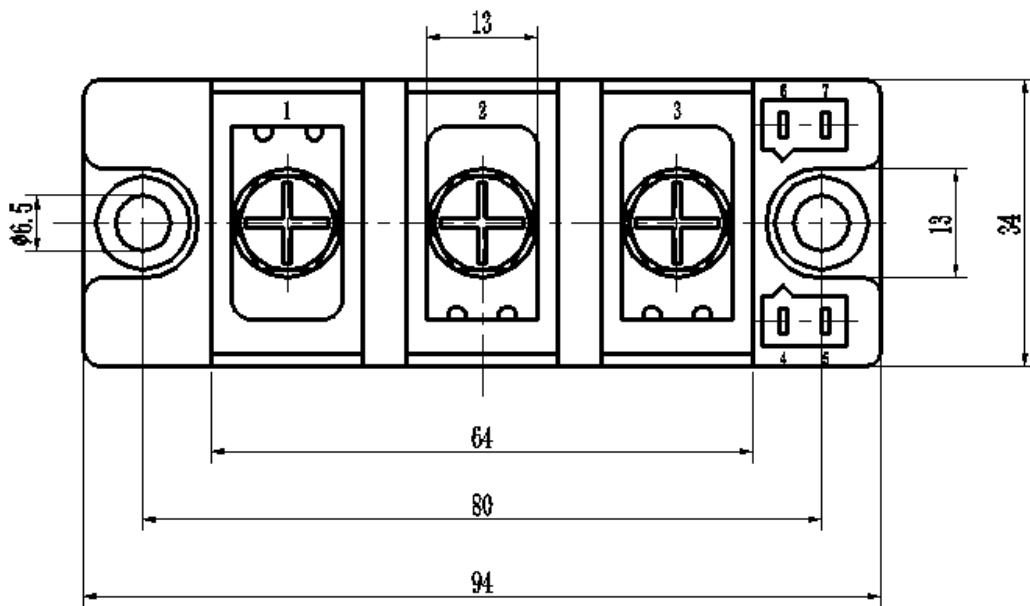
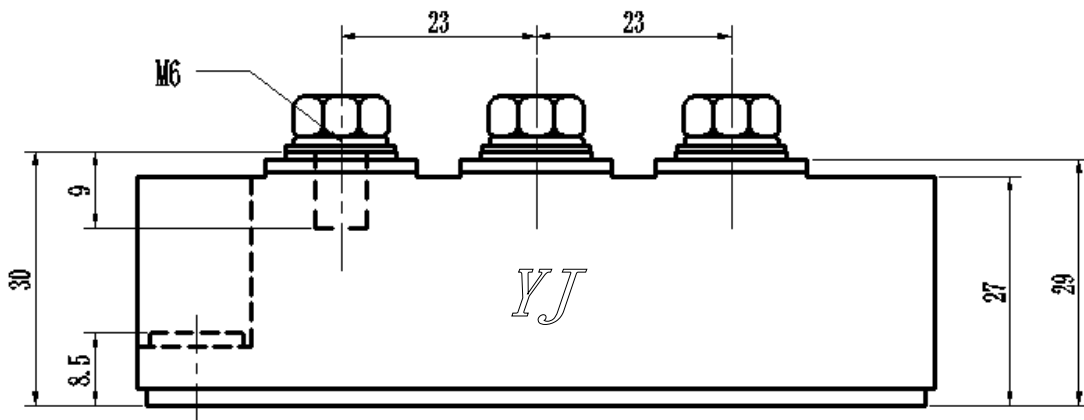

Fig4. Reverse Recovery Charge vs di_F/dt

Package Outline Information

CASE: F2N



Dimensions in mm